

G4A

PCB Power Relay

Miniature Single-pole Relay with 80A Surge Current and 20A Switching Current

- Capable of Switching Motor Load of 80-A Surge Current and 20A Switching/Cut-off Current
- Miniature, relay with high switching power and long endurance.
- Creepage distance conforms to UL and CSA standards.
- Highly noise-resistive insulation materials employed.
- Standard model available with flux protection construction.

RoHS Compliant

Model Number Legend

G4A-□□-□-□
 1 2 3 4

1. **Number of Poles** 2. **Contact Form** 3. **Terminal Shape** 4. **Special Function**
 1: 1-pole A: SPST-NO (1a) None: #250 quick-connect/PCB coil terminals E: For long endurance
 P : PCB terminals/PCB coil terminals

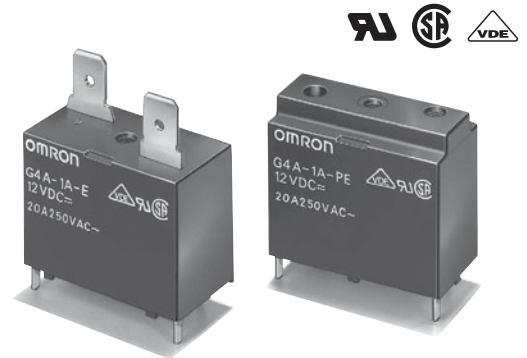

Ordering Information

Quick-connect/PCB coil terminals

Contact form	Load Contact Terminal	Coil terminal	Model	Rated voltage	Minimum packing unit
SPST-NO (1a)	#250 quick-connect terminals	PCB terminals	G4A-1A-E	12, 24 VDC	50 pcs/tray

PCB terminals

Contact form	Load Contact Terminal	Coil terminal	Model	Rated voltage	Minimum packing unit
SPST-NO (1a)	PCB terminals	PCB terminals	G4A-1A-PE	12, 24 VDC	50 pcs/tray

Note. When ordering, add the rated coil voltage to the model number.
 Example: G4A-1A-E 12 VDC

Rated coil voltage

Ratings

Coil

Item	Rated current (mA)	Coil resistance (Ω)	Must operate voltage (V)	Must release voltage (V)	Max. permissible voltage (V)	Power consumption (W)
Rated voltage						
12 VDC	75	160	70% max.	10% min.	160% (at 23°C)	0.9
24 VDC	37.5	640				

- Note 1. The rated current and coil resistance are measured at a coil temperature of 23°C with a tolerance of ±10%.
 2. The inductances shown above are reference values.
 3. Operating characteristics are measured at a coil temperature of 23°C.
 4. Max. permissible voltage refers to the maximum value in a varying range of operating power voltage, not a continuous voltage.

Contacts

Contact type	Single
Contact material	Ag-Alloy (Cd free)
Rated carry current	20 A
Max. switching voltage	250 VAC
Max. switching current	20 A

Motor Ratings

Load conditions	Switching frequency	Electrical durability
250 VAC: Inrush current: 80 A, 0.3 s (cosφ=0.7) Break current: 20 A (cosφ=0.9)	ON: 1.5 s OFF: 1.5 s	200,000 operations

Inverter Ratings

Load conditions	Switching frequency	Electrical durability
100 VAC: Inrush current: 200 A (0.P) Break current: 20 A	ON: 3 s OFF: 5 s	30,000 operations

Overload Durability (Reference Value)

Load conditions	Switching frequency	Electrical durability
250 VAC: Inrush current: 80 A Break current: 80 A (cosφ=0.7)	ON: 1.5 s OFF: 99 s	1,500 operations

Application Examples

- Air conditioner

Characteristics

Contact resistance *1	100 mΩ max.	
Operate time	20 ms max.	
Release time	10 ms max.	
Max. operating frequency	Mechanical	18,000 operations/hr
	Insulation resistance *2	1,000 MΩ min. (at 500 VDC)
Dielectric strength	Between coil and contacts	4,500 VAC 50/60 Hz for 1 min
	Between contacts of the same polarity	1,000 VAC 50/60 Hz for 1 min
Impulse withstand voltage	Between coil and contacts	8.5 kV 1.2 x 50
Vibration resistance	Destruction	10 to 55 to 10 Hz, 0.75 mm single amplitude (1.5 mm double amplitude)
	Malfunction	10 to 55 to 10 Hz, 0.75 mm single amplitude (1.5 mm double amplitude)
Shock resistance	Destruction	1,000 m/s ²
	Malfunction	200 m/s ²
Durability	Mechanical	2,000,000 operations min. (at 18,000 operations/hr)
	Motor load	200,000 operations min. (ON/OFF: 1.5 s)
	Inverter load	30,000 operations min. (ON: 3 s, OFF: 5 s)
Failure rate (P level) (reference value *3)		100 mA at 5 VDC
Ambient operating temperature		-20°C to 60°C (with no icing or condensation)
Ambient operating humidity		5% to 85%
Weight		Approx. 23 g

- Note. The data given above are initial values.
 *1. Measurement conditions: 5 VDC, 1 A, voltage drop method.
 *2. Measurement conditions: The insulation resistance was measured with a 500 VDC megohmmeter at the same locations as the dielectric strength was measured.
 *3. This value was measured at a switching frequency of 120 operations/min.

Engineering Data

Maximum Switching Capacity G4A-1A-(P)E

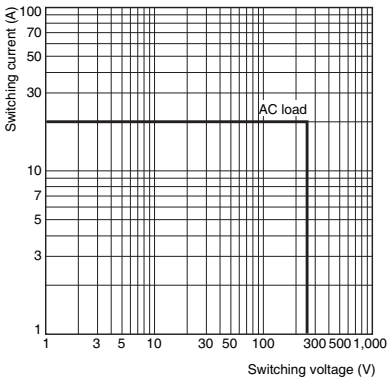

Durability G4A-1A-(P)E

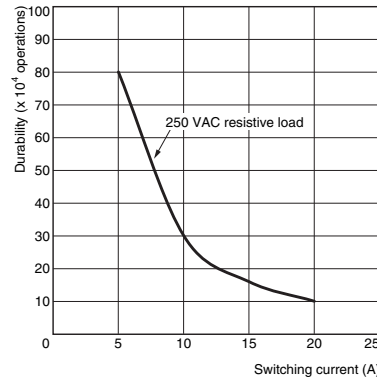

Ambient Temperature vs. Maximum Coil Voltage G4A-1A-(P)E

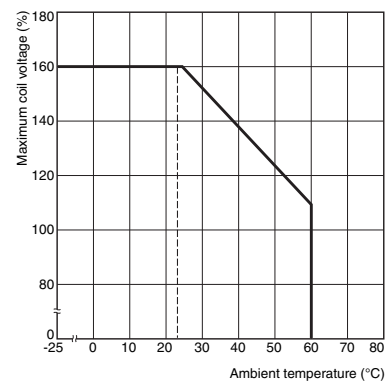

Note. The maximum coil voltage is the maximum voltage that can be applied to the relay coil.

Ambient Temperature vs. Must Operate and Must Release Voltages G4A-1A-(P)E

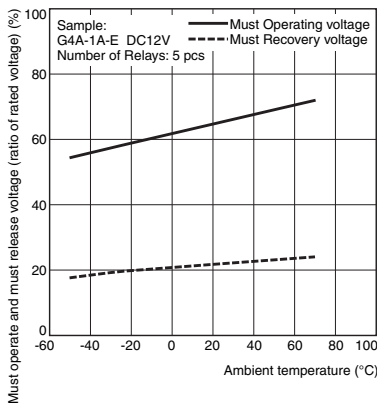

Shock Malfunction G4A-1A-(P)E

Number of Relays: 5 pcs

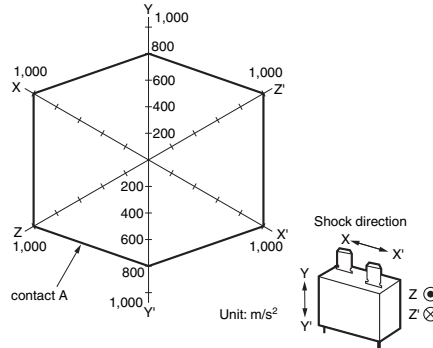

Test conditions: Shock is applied in $\pm X$, $\pm Y$, $\pm Z$ directions three times each with and without energizing the Relays to check the number of malfunctions.

Requirement: 200 m/s²

Dimensions

#250 quick-connect/PCB coil terminals G4A-1A-E

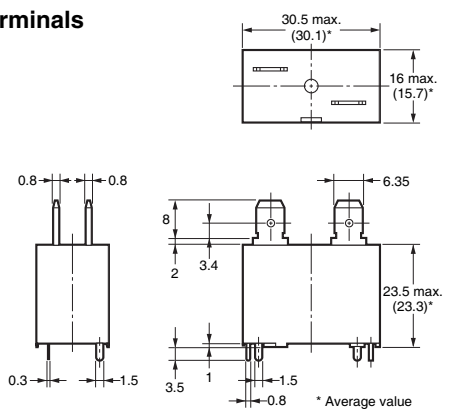
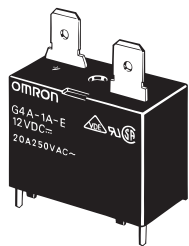

Mounting Holes (Bottom View)

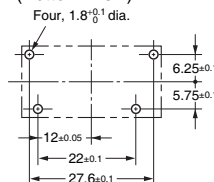

Terminal Arrangement/Internal Connections (Top View) (Bottom View)

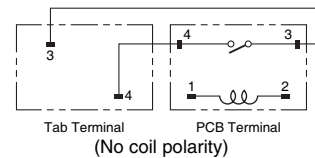

Straight PCB/PCB coil terminals G4A-1A-PE

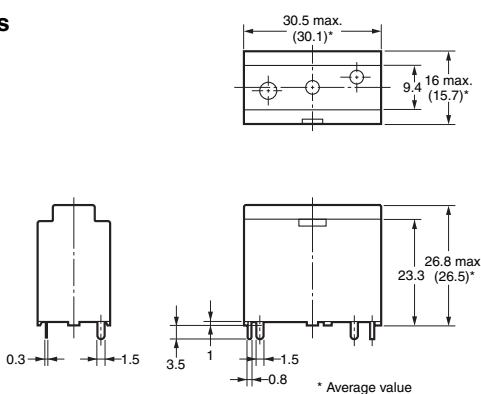
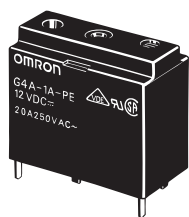

PCB Mounting Holes (Bottom View)

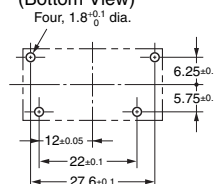

Terminal Arrangement/ Internal Connections (Bottom View)

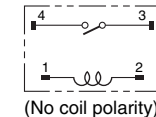

Approved Standards

●The rated values approved by each of the safety standards may be different from the performance characteristics individually defined in this datasheet.

UL Recognized (File No. E41643)

Model	Number of poles	Coil ratings	Contact ratings	Number of test operations
G4A-1A-E G4A-1A-PE	SPST-NO (1a)	5 to 100 VDC	20 A, 250 VAC (Resistive) 40°C	100,000
			15 A, 30 VDC (Resistive) 40°C	
			23 A, 277 VAC (General Purpose) 40°C	30,000

CSA Certified (File No. LR31928)

Model	Number of poles	Coil ratings	Contact ratings	Number of test operations
G4A-1A-E G4A-1A-PE	SPST-NO (1a)	5 to 100 VDC	20 A, 250 VAC (Resistive) 40°C	10,000
			15 A, 30 VDC (Resistive) 40°C	
			23 A, 277 VAC (General Purpose) 40°C	30,000

EN/IEC, VDE Certified (Registration No. 107293)

Model	Number of poles	Coil ratings	Contact ratings	Number of test operations
G4A-1A-E G4A-1A-PE	SPST-NO (1a)	5, 12, 18, 24 VDC	20 A, 250 VAC (cosφ=1.0) 50°C	100,000

Precautions

●Please refer to “PCB Relays Common Precautions” for correct use.

Correct Use

●Mounting

- When mounting more than two Relays side by side, keep a 3 mm gap horizontally and vertically between Relays to ensure a good heat dissipation. It may cause a malfunction if heat is not dissipated smoothly from the Relay.

●Terminals

- The terminals fit FASTON receptacle 250 and are suitable for positive-lock mounting. Use only Faston terminals with the specified numbers. Select leads for connecting Faston receptacles with wire diameters that are within the allowable range for the load current. Do not apply excessive force to the terminals when mounting or dismounting the Faston receptacle. Insert and remove terminals carefully one at a time. Do not insert terminals at an angle, or insert/remove multiple terminals at the same time. Refer to the following table for examples of positive-lock connectors made by AMP. Contact the manufacturer directly for details on connectors including availability.

Type	Receptacle terminals	Positive housing
#250 terminals (width: 6.35 mm)	AMP 170333-1 (170327-1)	AMP 172076-1 natural color
	AMP 170334-1 (170328-1)	AMP 172076-4 yellow
	AMP 170335-1 (170329-1)	AMP 172076-5 green
		AMP 172076-6 blue

* The numbers shown in parentheses are for air-feeding.

●Other Precautions

- This Relay is suitable for power load switching of air-conditioning compressors and power supplies, etc. Do not use the G4A to switch micro loads less than 100 mA, such as in signal applications.

• Application examples provided in this document are for reference only. In actual applications, confirm equipment functions and safety before using the product.
• Consult your OMRON representative before using the product under conditions which are not described in the manual or applying the product to nuclear control systems, railroad systems, aviation systems, vehicles, combustion systems, medical equipment, amusement machines, safety equipment, and other systems or equipment that may have a serious influence on lives and property if used improperly. Make sure that the ratings and performance characteristics of the product provide a margin of safety for the system or equipment, and be sure to provide the system or equipment with double safety mechanisms.

Note: Do not use this document to operate the Unit.