

Power relay VF7



~~Powertrain Systems~~



~~Chassis Systems~~



~~Safety~~



Security



~~Body~~



Driver Information



~~Convenience~~

Description

Features

- Limiting continuous current 70 A
- Dimensional characteristics and the functional allocation of the plug-in terminals to ISO 7588
- Standardized dimensions
- Plug-in or PCB terminals

Typical applications

- Rear window defogger
- Battery disconnection
- Power distribution (clamp 15)

Please contact Tyco Electronics for relay application support.



~~Car Industry~~



~~Truck Industry~~



~~Other Industry~~

VF7_3d1

Design

Dustproof; protection class IP 54 to IEC 529 (EN 60 529); with either mounting bracket or mounting clip

Weight

Approx. 1.3 oz. (38 g)

Nominal voltage

6 V, 12 V or 24 V; other nominal voltages available on request

Terminals

Quick connect terminals similar to ISO 8092-1 coil 6.3 x 0.8 mm, load 9.5 x 1.2 mm; surfaces tin-plated or PCB terminals

Accessories

Connectors see page 189

Special models on request

- Integrated components: resistor, varistor, diode
- Special labels
- Special cover shapes

Conditions

All parametric, environmental and endurance tests are performed according to EIA Standard RS-407-A at standard test conditions unless otherwise noted:

23 °C ambient temperature, 20-50% RH, 29.5 ± 1.0" Hg (998.9 ± 33.9 hPa).

Please also refer to the Application Recommendations in this catalog for general precautions.

Disclaimer

All technical performance data apply to the relay as such, specific conditions of the individual application are not considered. Please always check the suitability of the relay for your intended purpose. We do not assume any responsibility or liability for not complying herewith. We recommend to complete our questionnaire and to request our technical service. Any responsibility for the application of the product remains with the customer only. All specifications are subject to change without notification. All rights of Tyco are reserved.

Power relay VF7

Dimensional drawing

Dust cover with quick connect terminals

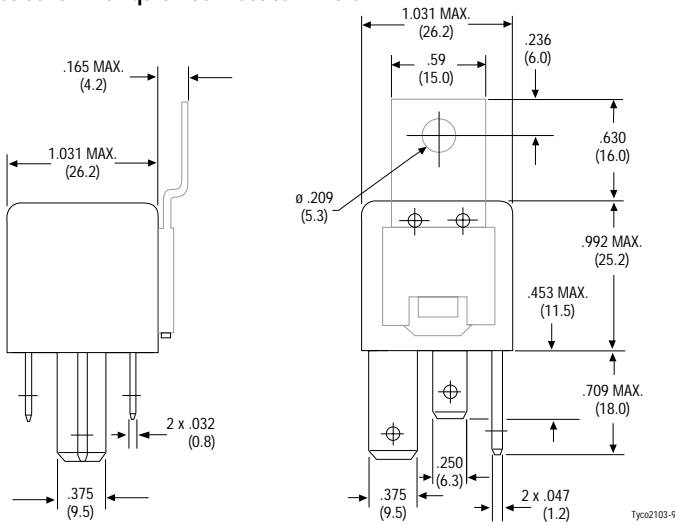

View of the terminals (bottom view)

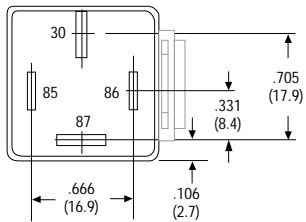

PCB terminals

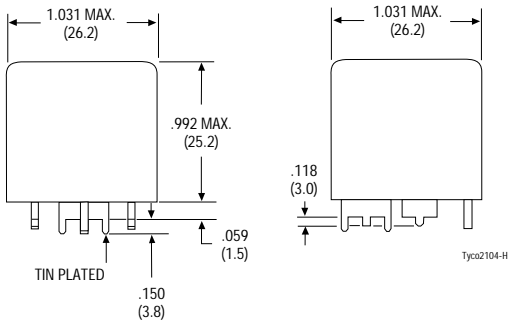

View of the terminals (bottom view)

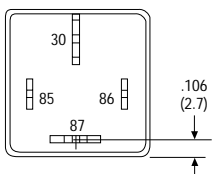

Mounting holes (bottom view)

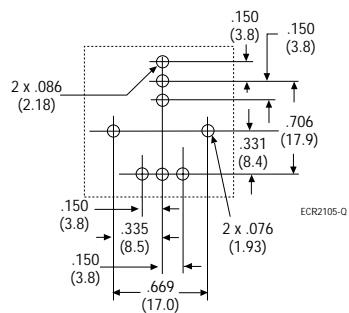

Power relay VF7

Contact data

Contact configuration	Make contact/ Form A
Circuit symbol (see also Pin assignment)	
Limiting continuous current at 23 °C at 85 °C	70 A 50 A
Contact material	AgNi0.15
Max. switching voltage/power	See load limit curve
Max. switching current ¹⁾	
On ²⁾	240 A
Off	70 A
Min. recommended load ³⁾	1 A at 5 V
Voltage drop at 70 A (initial) NO contact	Typ. 70 mV, 200 mV max.
Mechanical endurance (without load)	> 10 ⁷ operations
Electrical endurance (example of resistive load, further information on request)	> 1 x 10 ⁵ operations 70 A, 14 V at 23 °C > 2 x 10 ⁵ operations 50 A, 14 V
Max. switching rate at nominal load	6 operations per minute (0.1 Hz)

¹⁾ The values apply to a resistive or inductive load with suitable spark suppression and at maximum 13.5 V for 12 V load voltages.

²⁾ For a load current duration of maximum 3 s for a make/break ratio of 1:10.

³⁾ See chapter Diagnostics in our Application Recommendations on page 18.

Load limit curve

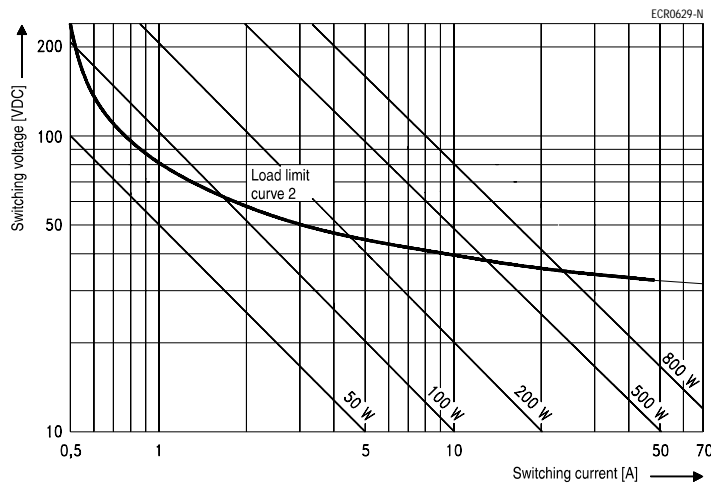

Load limit curve 2 ≙ safe shutdown,
no stationary arc (make contact)

Pin assignment

1 make contact/
1 form A

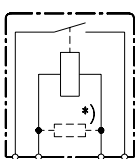

30 85 86 87
ECR1100 - E

*) Models with resistor or diode in parallel to the coil on request.

Power relay VF7

Coil data

Available for nominal voltages	12, 24 V
Nominal power consumption of the unsuppressed coil at nominal voltage	2.0 W
Nominal power consumption at nominal voltage with suppression resistor	2.2 W
Test voltage winding/contact and contact/contact	500 VAC _{rms}
Ambient temperature range	- 40 to + 125 °C
Operate time at nominal voltage ¹⁾	Typ. 7 ms
Release time at nominal voltage ¹⁾	Typ. 2 ms

¹⁾ For unsuppressed relay coil

N.B.

A low resistive suppression device in parallel to the relay coil increases the release time and reduces the lifetime caused by increased erosion and/or higher risk of contact tack welding.

Operating voltage range

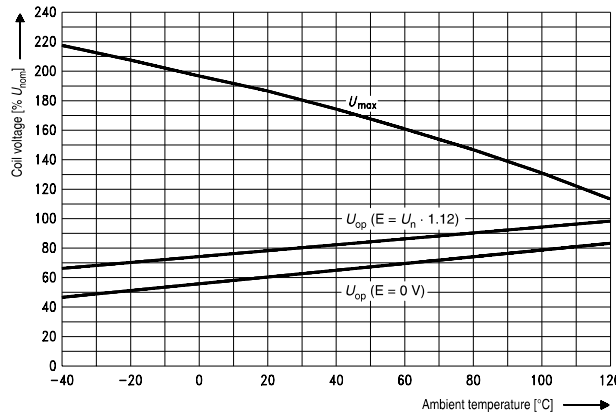

Does not take into account the temperature rise due to the contact current
E = pre-energization

ECR0701-J

Ambient temperature vs. coil voltage for continuous duty

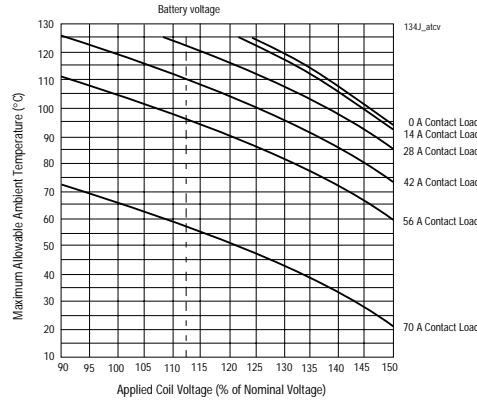

Assumptions:

1. Still air
2. Nominal coil resistance
3. Maximum mean coil temperature = 180 °C
4. Coil temperature rise due to load = 2 °C at 14 A
= 4 °C at 28 A
= 26 °C at 42 A
= 40 °C at 56 A
= 78 °C at 70 A
5. Thermal resistance and power dissipation based on coil resistance at 180 °C
6. Curves are based on 1.6 W at 23 °C
7. When full lifetime is at high ambient and high load current, subtract 25 °C from maximum allowable ambient temperature.

Mechanical data

Cover retention	
Axial force	150 N (33.8 lbs)
Pul force	200 N (45 lbs)
Push force	200 N (45 lbs)
Terminals	
Pull force	100 N (22.5 lbs)
Push force	100 N (22.5 lbs)
Resistance to bending, force applied to front	10 N (2.25 lbs) ¹⁾
Resistance to bending, force applied to side	10 N (2.25 lbs) ¹⁾
Torsion	0.3 Nm
Enclosures	
Dust cover	Protects relay from dust. For use in passenger compartment or enclosures.

¹⁾ Values apply 2 mm from the end of the terminal. When the force is removed, the terminal must not have moved by more than 0.3 mm.

Power relay VF7

Operating conditions		-40 °C to 155 °C		
Temperature range, storage				
Test	Relevant standard	Testing as per	Dimension	Comments
Climatic cycling with condensation	EN ISO 6988		6 cycles	Storage 8/16 h
Temperature cycling	IEC 68-2-14	Nb	10 cycles	- 40/+ 85 °C (5 °C per min.)
Damp heat				
cyclic	IEC 68-2-30	Db, Variant 1	6 cycles	Upper air temperature 55 °C
constant	IEC 68-2-3	Ca	56 days	
Corrosive gas	IEC 68-2-42	10 ± 2 cm ³ /m ³ SO ₂	10 days	
	IEC 68-2-43	1 ± 0.3 cm ³ /m ³ H ₂ S	10 days	
Vibration resistance	IEC 68-2-6 (sine sweep)		10-500 Hz min. 18 g	No change in the switching state > 10 µs
Shock resistance	IEC 68-2-27 (half sine pulse form)		min. 30 g 6 ms	
Load dump	ISO 7637-1 (12 V) ISO 7637-2 (24 V)	Test pulse 5 Test pulse 5	Vs =+ 86.5 V Vs =+ 200 V	
Jump start	24 V for 5 minutes conducting nominal current at 23 °C			
Drop test	Capable of meeting specifications after 1.0 m (3.28 foot) drop onto concrete			
Flammability	UL94-HB or better (meets FMVSS 302) ¹⁾			
Overload current ²⁾	95 A, 1800 s / 140 A, 5 s / 245 A, 0.5 s / 420 A, 0.1 s			

¹⁾ FMVSS: Federal Motor Vehicle Safety Standard.

²⁾ Current and time are compatible with circuit protection by a typical 70 A automotive fuse. Relay will make, carry and break the specified current.

Ordering information (Production in USA only)

Part numbers (see table below for coil data)		Contact arrangement	Contact material	Enclosure	Special features
Relay part number	Tyco order number				
12 V Plug-in relays					
VF7-11F11	4-1393306-5	1 Form A	AgNi0.15	Dust cover	
VF7-11F11-S01 ¹⁾	4-1393306-6	1 Form A	AgNi0.15	Dust cover	Resistor
VF7-41F11	5-1393306-8	1 Form A	AgNi0.15	Dust cover	Bracket
VF7-41F11-C05 ¹⁾	1432055-1	1 Form A	AgNi0.15	Dust cover, sealed	Bracket, resistor
VF7-41F11-S01 ¹⁾	1-1393302-6	1 Form A	AgNi0.15	Dust cover	Bracket, resistor
12 V PCB relays (clinch)					
VF7-11F12	1-1393302-3	1 Form A	AgNi0.15	Dust cover	
VF7-11F12-C05 ¹⁾	1432556-1	1 Form A	AgNi0.15	Dust cover, sealed	Resistor
24 V Plug-in relays					
VF7-11H11	1-1393302-4	1 Form A	AgNi0.15	Dust cover	
VF7-41H11	1-1393302-7	1 Form A	AgNi0.15	Dust cover	Bracket
VF7-41H11-S08 ¹⁾	6-1393306-7	1 Form A	AgNi0.15	Dust cover	Bracket, diode
24 V PCB relays (clinch)					
VF7-11H12	1-1393302-5	1 Form A	AgNi0.15	Dust cover	
VF7-11H12-C01 ¹⁾	6-1419148-2	1 Form A	AgNi0.15	Dust cover	

¹⁾ Optional coil suppression: add suffix -S01 for 680 Ω resistor in parallel with 12 VDC coil,
-S08 for 2,700 Ω resistor in parallel with 24 VDC coil.

Epoxy sealed construction: add suffix -C01 for epoxy sealed unit.

Epoxy sealed construction with parallel resistor: add suffix -C05 for epoxy sealed unit.

Coil versions

Coil data for VF7	Rated coil voltage (V)	Coil resistance +/- 10% (Ω)	Must operate voltage (V)	Must release voltage (V)	Allowable overdrive ¹⁾ voltage (V)	
					at 23 °C	at 85 °C
VF4-***F**-**	12	72	7.2	1.2	18.1	14.1
VF4-***H**-**	24	288	14.4	2.4	36.2	28.2

¹⁾ Allowable overdrive is stated with no load applied and minimum coil resistance.

Standard delivery packs (orders in multiples of delivery pack)

VF7: 300 pieces